

*[Handwritten signature]*

Test Booklet No.

110553454



Test Booklet Code

12

ENGLISH

KAILASH

Do not open this Test Booklet until you are asked to do so.  
This Booklet contains 32 pages, including Rough Pages.

**Important Instructions :**

1. The Answer Sheet is inside this Test Booklet. When you are directed to open the Test Booklet, take out the Answer Sheet and fill in the particulars on ORIGINAL Copy carefully with blue/black ball point pen only.
2. The test is of 3 hours duration and the Test Booklet contains 180 multiple-choice questions (4 options with a single correct answer) from Physics, Chemistry and Biology (Botany and Zoology).
3. Wherever the symbols/constants are not mentioned, they are to be considered as per their standard meaning/value.
4. Each question carries 4 marks. For each correct response, the candidate will get 4 marks. For each incorrect response, one mark will be deducted from the total scores. The maximum marks are 720.
5. Use Blue/Black Ball Point Pen only for writing particulars on this page/markings responses on the Answer Sheet.
6. Rough work is to be done in the space provided for this purpose in the Test Booklet only.
7. On completion of the test, the candidate must hand over the Answer Sheet (ORIGINAL and OFFICE Copy) to the Invigilator before leaving the Room/Hall. The candidates are allowed to take away this Test Booklet with them.
8. The CODE for this Booklet is "12". Make sure to enter this Booklet code in the OMR Answer Sheet.
9. The candidates should ensure that the Answer Sheet is not folded. Do not make any stray marks on the Answer Sheet. Do not write your Roll No. anywhere else except in the specified space in the Test Booklet/Answer Sheet.
10. Use of white fluid for correction is not permissible on the Answer Sheet.
11. Each candidate must show on demand his/her Admit Card to the Invigilator.
12. No candidate, without special permission of the Centre Superintendent or Invigilator, should leave his/her seat.
13. The candidates should not leave the Examination Hall without handing over their Answer Sheet to the Invigilator on duty and sign (with time) the Attendance Sheet twice. Cases, where a candidate has not signed the Attendance Sheet a second time, will be deemed not to have handed over the Answer Sheet and dealt with as an Unfair Means case.
14. Use of Electronic/Manual Calculator is prohibited.
15. The candidates are governed by all Rules and Regulations of the examination with regard to their conduct in the Examination Room/Hall. All cases of unfair means will be dealt with as per the Rules and Regulations of this examination along with Public Examinations (Prevention of Unfair Means) Act, 2024.
16. No part of the Test Booklet and Answer Sheet shall be detached under any circumstances.
17. The candidates will write the Correct Test Booklet Code as given in the Test Booklet/Answer Sheet in the Attendance Sheet.
18. If a candidate marks more than one answer for a question in the OMR Answer Sheet, it will be treated as incorrect and negative marking will be applicable.

26

$n = 100$   
 $r = 5 \text{ cm}$   
 $\frac{\mu_0 n i}{2R}$

1. A 100-turn closely wound circular coil of radius 5 cm has a magnetic field of  $3.14 \times 10^{-3} \text{ T}$  at its centre. The current flowing through the coil, and the magnitude of the magnetic moment of this coil are, respectively :

- (Take  $\mu_0 = 4\pi \times 10^{-7} \text{ T m/A}$ )
- (1) 2.5 A, 2 A m<sup>2</sup>                      (2) 2.5 A, 20 A m<sup>2</sup>  
 (3) 2 A, 4 A m<sup>2</sup>                        (4) 2 A, 10 A m<sup>2</sup>

2. Match List I with List II :

- |                                 |                              |
|---------------------------------|------------------------------|
| <b>List I</b>                   | <b>List II</b>               |
| A. $E = hv$                     | I. de Broglie wavelength     |
| B. Diffraction and Interference | II. Particle nature of light |
| C. $\lambda = h/p$              | III. Wave nature of light    |
| D. Compton effect               | IV. Energy of photon         |

Choose the correct answer from the options given below :

- (1) A-IV, B-III, C-I, D-II  
 (2) A-I, B-IV, C-III, D-II  
 (3) A-IV, B-I, C-II, D-III  
 (4) A-IV, B-III, C-II, D-I

3. The current I in the circuit shown below is :  
 (All diodes are ideal and identical)

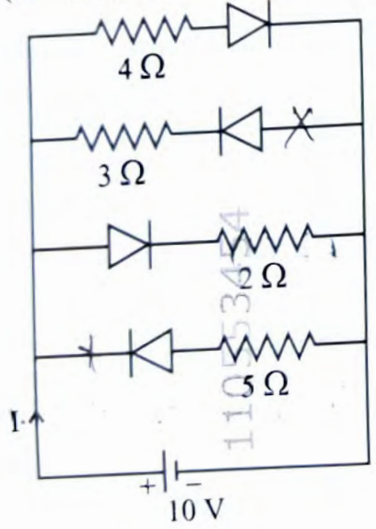

Handwritten calculations:  
 $\frac{4 \times 3}{4+3} = \frac{12 \times 2}{7} = \frac{24}{7}$   
 $\frac{9 \times 2}{4+2} = \frac{18}{6} = 3$   
 $\frac{4 \times 4}{4+2} = \frac{16}{6} = \frac{8}{3}$   
 $\frac{4 \times 5}{4+5} = \frac{20}{9}$   
 $\frac{24}{7} + 3 + \frac{8}{3} + \frac{20}{9} = \frac{261}{9} + \frac{28}{3} + \frac{20}{9} = \frac{261+84+20}{9} = \frac{365}{9}$

- (1)  $\frac{5}{3} \text{ A}$                                       (2)  $\frac{15}{2} \text{ A}$   
 (3)  $\frac{1}{3} \text{ A}$                                       (4)  $\frac{5}{9} \text{ A}$

4. The speed of light in vacuum is taken as unity. If light takes 6 min 40 s to reach the Earth from the Sun, the distance between the Sun and the Earth in new unit is :

- (1)  $3 \times 10^8$                                   (2)  $3 \times 10^{10}$   
 (3) 400                                        (4) 500

5. The following plots show variation of velocity (v) with time (t), of a ball thrown vertically upward, and falling back. Which of the following plots is/are correct ?

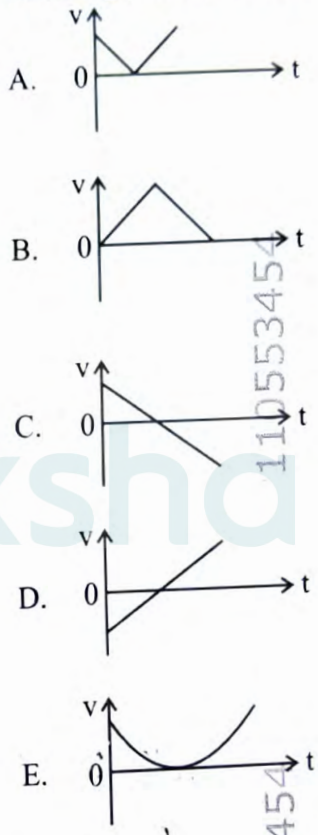

- (1) C only                                      (2) A and E only  
 (3) D only                                      (4) B only

6. In a vernier callipers, 20 VSD coincide with 16 MSD (each division of length 1 mm). The least count of the vernier callipers is :

- (1) 0.01 cm                                  (2) 0.1 cm  
 (3) 0.02 cm                                  (4) 0.2 cm

$\frac{10}{4} \times 3 = \frac{30}{4}$



7. An ac circuit contains a resistance of  $1\text{ k}\Omega$ , a capacitor of  $0.1\text{ }\mu\text{F}$  and an inductor of  $1\text{ mH}$  connected in series. The resonance frequency of the circuit is approximately :

- (1)  $10.1\text{ kHz}$                       (2)  $20.7\text{ kHz}$   
 (3)  $15.9\text{ kHz}$                       (4)  $13.5\text{ kHz}$

8. The figure given below shows a long straight solid wire of circular cross-section of radius 'a' carrying steady current  $I$ . The current  $I$  is uniformly distributed across its cross-section. The plot which correctly represents the variation of magnetic field ( $B$ ) with distance ( $r$ ) from the axis of the conductor in the region is :

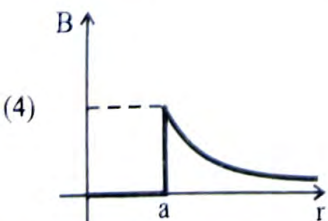
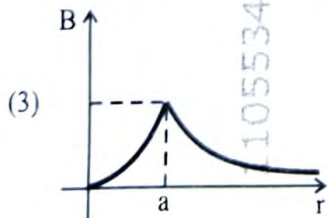
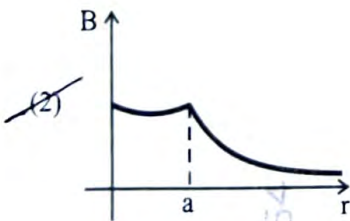
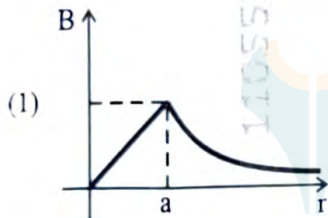

9. A uniform metallic wire having resistance  $4\text{ }\Omega$  is bent to form a square loop (ABCD) (see figure). A resistance of  $2\text{ }\Omega$  is connected between points B and D and a battery of  $2\text{ V}$  is connected across points A and C as shown in the figure. Now the value of current ( $I$ ) is :

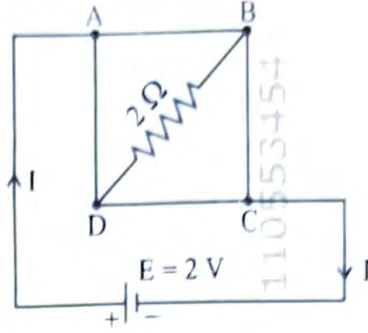

- (1)  $2\text{ A}$                                       ~~(2)  $4\text{ A}$~~   
 (3)  $8\text{ A}$                                       (4)  $4.5\text{ A}$

10. An unknown nucleus has a nuclear density of  $2.29 \times 10^{17}\text{ kg/m}^3$  and mass of  $19.926 \times 10^{-27}\text{ kg}$ . Its mass number  $A$  is approximately :

(Take  $R_0 = 1.2 \times 10^{-15}\text{ m}$ ,  $4\pi = 12.56$ )

- (1)  $12$     (2)  $19$   
 (3)  $20$     (4)  $16$

11. A rectangular wire loop of sides  $8\text{ cm}$  and  $3\text{ cm}$  with a small cut, is moving out of a region of uniform magnetic field of magnitude  $0.3\text{ T}$  directed normal to the plane of the loop. The emf developed across the cut, if the velocity of the loop is  $2\text{ cm s}^{-1}$ , in a direction normal to the shorter side of the loop, will be :

- (1)  $1.8 \times 10^{-4}\text{ volt}$                       (2)  $1.2 \times 10^{-4}\text{ volt}$   
 (3)  $1.3 \times 10^{-4}\text{ volt}$                       (4)  $4.8 \times 10^{-4}\text{ volt}$

12. A galvanometer of resistance  $100\text{ }\Omega$  gives full scale deflection for a current of  $1\text{ mA}$ . It is converted into an ammeter of range  $0 - 10\text{ A}$ . The shunt required is :

- (1)  $0.01\text{ }\Omega$                                       (2)  $0.10\text{ }\Omega$   
 (3)  $0.001\text{ }\Omega$                                       (4)  $1.0\text{ }\Omega$

13. In Young's double slit experiment, using monochromatic light of wavelength  $\lambda$ , the intensity of light at a point on the screen where the path difference is  $\lambda$  is  $K$  units. The intensity of light at a point where the path difference is  $\frac{\lambda}{3}$  will be :

- (1)  $\frac{K}{4}$  (2)  $K$   
 (3)  $\frac{K}{2}$  (4)  $2K$

14. The magnitude and direction of the acceleration produced in a body of mass 5 kg when two mutually perpendicular forces 8 N and 6 N act on it, are respectively :

- (1)  $2 \text{ m s}^{-2}$ ;  $\tan^{-1}(3/4)$  with 6 N force  
 (2)  $2 \text{ m s}^{-2}$ ;  $\tan^{-1}(4/3)$  with 8 N force  
 (3)  $2 \text{ m s}^{-2}$ ;  $\tan^{-1}(3/4)$  with 8 N force  
 (4)  $20 \text{ m s}^{-2}$ ;  $\tan^{-1}(4/3)$  with 8 N force

15. Five capacitors of capacitances  $C_1 = C_2 = C_3 = C_4 = 10 \mu\text{F}$  and  $C_5 = 2.5 \mu\text{F}$  are connected as shown, along with a battery of 50 V.

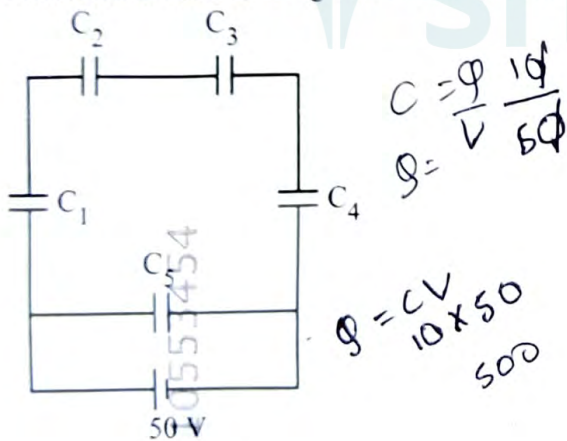

The equivalent capacitance and the charges on each capacitor respectively are :

- (1)  $5 \mu\text{F}$ ,  $125 \mu\text{C}$  on all capacitors  
 (2)  $5 \mu\text{F}$ ,  $250 \mu\text{C}$  on all capacitors  
 (3)  $4 \mu\text{F}$ ,  $250 \mu\text{C}$  on  $C_1$  to  $C_4$  and  $125 \mu\text{C}$  on  $C_5$   
 (4)  $5 \mu\text{F}$ ,  $125 \mu\text{C}$  on  $C_1$  to  $C_4$  and  $25 \mu\text{C}$  on  $C_5$

16. In a metre bridge experiment (see figure), the positions of the cell, E, and galvanometer, G, are interchanged. We shall observe in the galvanometer :

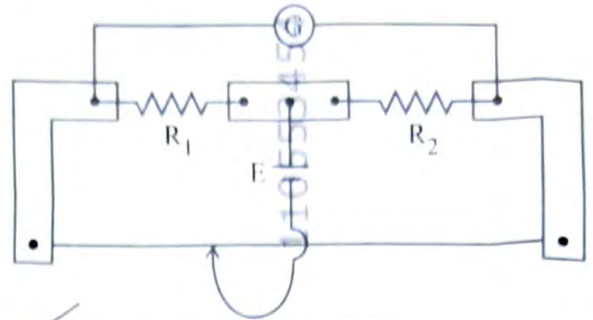

- (1) Only the right-sided deflection  
 (2) Only the left-sided deflection  
 (3) There will be no deflection irrespective of the position of the jockey  
 (4) Both right-sided and left-sided deflection and at balance point, no deflection

17. The power of a crane, which lifts a mass of 1000 kg to a height of 20 m in 10 s is : ( $g = 9.8 \text{ m/s}^2$ )

- (1) 19.6 W (2) 39.2 W  
 (3) 39.2 kW (4) 19.6 kW

18. Match List I with List II :

| List I             | List II  |
|--------------------|--|
| A. Young's Modulus | I. $\frac{\Delta d}{\Delta L} \left( \frac{L}{d} \right)$    |
| B. Compressibility | II. $\frac{FL}{A(\Delta L)}$                                 |
| C. Bulk Modulus    | III. $-\frac{1}{\Delta P} \left( \frac{\Delta V}{V} \right)$ |
| D. Poisson's Ratio | IV. $-P \left( \frac{V}{\Delta V} \right)$                   |

Choose the **correct** answer from the options given below :

- (1) A-I, B-IV, C-III, D-II  
 (2) A-IV, B-I, C-II, D-III  
 (3) A-III, B-II, C-I, D-IV  
 (4) A-II, B-III, C-IV, D-I

19. In a concave lens, a ray of light emanating from the object parallel to the principal axis of the lens, after refraction :

- (1) emerges parallel to the principal axis.
- (2) appears to diverge from the first principal focus.
- (3) passes through  $2F$ , which is the radius of curvature of the lens.
- (4) passes through the second principal focus.

20. A thin wire of length 'L' and linear mass density 'm' is bent into a circular ring (in x-y plane) with centre 'C' as shown in figure. The moment of inertia of the ring about an axis yy' will be :

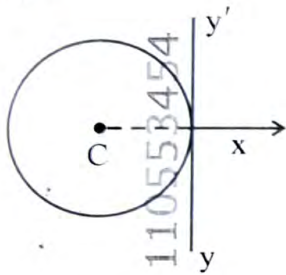

- (1)  $\frac{3 mL^3}{8 \pi^2}$
- (2)  $\frac{3 mL^3}{8 \pi}$
- (3)  $\frac{3 mL^2}{8 \pi^2}$
- (4)  $\frac{3 mL^2}{8 \pi}$

21. Each side of a metallic cube of mass 5.580 kg is measured to be 9.0 cm. Keeping the significant figures in view, the density of the material of the cube can be best expressed as  $X \times 10^3 \text{ kg m}^{-3}$ , where the value of X is :

- (1) 7.654
- (2) 7.7
- (3) 7.65
- (4) 7.6

22. For a travelling harmonic wave

$y(x, t) = 2.0 \cos 2\pi(10t - 0.0080x + 0.35)$ , where x and y are in cm and t in s. The phase difference between oscillatory motion of two points separated by a distance of 0.5 m is :

- (1)  $8 \pi \text{ rad}$
- (2)  $0.08 \pi \text{ rad}$
- (3)  $0.008 \pi \text{ rad}$
- (4)  $0.8 \pi \text{ rad}$

23. A ray of monochromatic light is passing through an equilateral prism (ABC) as shown in the figure. The refracted ray (QR) is parallel to its base (BC) and the angle of incidence (i) is  $50^\circ$ . Then the angle of deviation ( $\delta$ ) is :

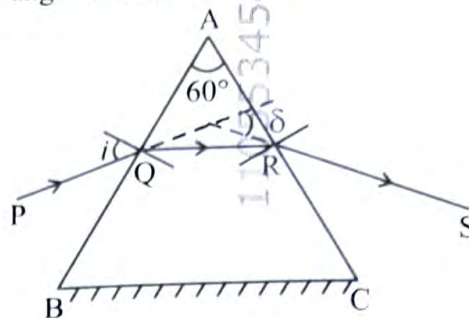

- (1)  $40^\circ$
- (2)  $45^\circ$
- (3)  $55^\circ$
- (4)  $35^\circ$

24. In the circuit shown below, the voltage appearing across the diode D will be of the form :

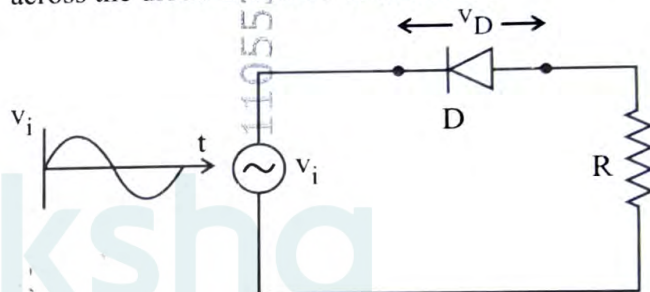

- (1)
- (2)
- (3)
- (4)

25. For a simple pendulum, having time period  $T$ , the variation of kinetic energy (K.E.) with time ( $t$ ) is represented by :

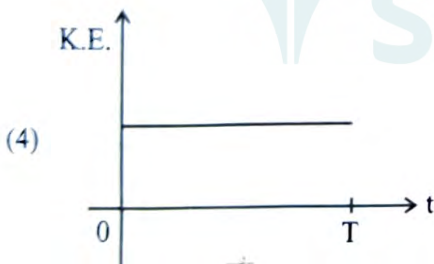
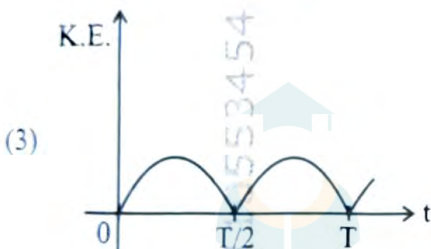
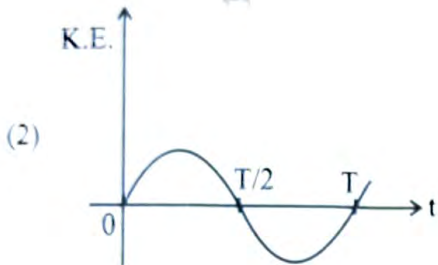
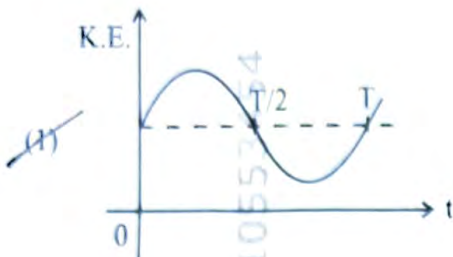

344  
x6  
-----  
374  
6x12x2

26. A resistor is connected to a battery of 12 V emf and internal resistance  $2 \Omega$ . If the current in the circuit is 0.6 A, the terminal voltage of the battery is :

- (1) 10 V (2) 10.8 V (3) 12 V (4) 1.2 V

27. The amount of work done to raise a mass 'm' from the surface of the Earth to a height equal to the radius of the Earth 'R', will be :

- (1)  $2 mg R$  (2)  $mg R$   
(3)  $mg \frac{R}{4}$  (4)  $mg \frac{R}{2}$

28. An electric heater supplies heat to a system at a rate of 100 W. If the system performs work at a rate of 75 J/s, then the rate at which internal energy increases will be :

- (1) 125 W (2) 100 W  
(3) 25 W (4) 75 W

29. A room heater is rated 400 W, 220 V. If the supply voltage drops to 200 V, what will be the power consumed (approximately) ?

- (1) 121 W (2) 331 W  
(3) 200 W (4) 400 W

30. When a ruler falls vertically, 5 different persons catch it with different reaction times.

( $g = 9.8 \text{ m s}^{-2}$ )

- A. Person A has reaction time of 0.20 s  
B. Person B has reaction time of 0.22 s  
C. Person C has reaction time of 0.18 s  
D. Person D has reaction time of 0.19 s  
E. Person E has reaction time of 0.21 s

What is the correct order of the distance travelled by the ruler for each person ?

- (1)  $C > D > A > B > E$   
(2)  $C > D > A > E > B$   
(3)  $B > E > A > C > D$   
(4)  $B > E > A > D > C$

31. Consider two uncharged capacitors of equal capacitance 200 pF. One of them is charged by a 100 V supply and disconnected. Now this capacitor is connected to the uncharged capacitor. The amount of electrostatic energy lost in the process is :

- (1)  $1.0 \times 10^{-6} \text{ J}$  (2)  $0.5 \times 10^{-6} \text{ J}$   
(3) 0.5 J (4) 1.0 J

32. Savitha, a XI standard student, while conducting an experiment to determine the effective length of a simple pendulum L, notes down the data of time taken to complete 30 oscillations as 60 s and hence calculates the length of the simple pendulum as :

(Take  $\pi^2 = 9.8$ , and  $g = 9.8 \text{ m/s}^2$ )

- (1) 2 m (2) 0.75 m  
(3) 1.5 m (4) 1 m

33. The peak value of an alternating current is 5 A and frequency is 60 Hz. How long will the current, starting from zero, take to reach the peak value ?

- (1)  $\frac{1}{240}$  s (2)  $\frac{1}{30}$  s  
(3)  $\frac{1}{120}$  s (4)  $\frac{1}{60}$  s

34. In interference and diffraction, the light energy is redistributed. If it reduces in one region, producing a dark fringe, it increases in another region, producing a bright fringe.

A. As there is no gain or loss of energy, these phenomena are consistent with the principle of conservation of energy.

B. Diffraction and interference are characteristics exhibited only by light waves.

Choose the **correct** answer from the options given below :

- (1) A is true, but B is false  
(2) A is true and B is also true  
(3) A is false, but B is true  
(4) Both A and B are false

35. A box of mass 15 kg is kept on the floor of a stationary trolley. The coefficient of static friction between the box and the trolley is 0.12. Keeping the box in stationary state over the trolley, the maximum acceleration with which the trolley can be moved horizontally in  $\text{m s}^{-2}$  is :

- ( $g = 10 \text{ m/s}^2$ )  
(1) 1.5 (2) 1.8  
(3) 2.1 (4) 1.2

36. The sum of kinetic energy and potential energy of a simple pendulum bob is 0.02 joule. The speed of the simple pendulum bob at equilibrium position is approximately :

(Consider mass of the bob = 20 g)

- (1) 1.41 m/s (2) 14.1 m/s  
(3) 0.2 m/s (4) 2.0 m/s

37. Four statements are given (A is mass number) :

- A. The volume of a nucleus is proportional to  $A^{1/3}$ .  
B. The volume of a nucleus is proportional to A.  
C. The difference in mass of an atom and its nucleus is called the mass defect.  
D. The difference in mass of a nucleus and its constituents is called the mass defect.

Choose the **correct** answer from the options given below :

- (1) B and D are true, but A and C are false  
(2) A and D are true, but B and C are false  
(3) A and C are true, but B and D are false  
(4) B and C are true, but A and D are false

38. The angular speed of a flywheel is increased from 600 rpm to 1200 rpm in 10 s. The number of revolutions completed by the flywheel during this time is :

- (1) 600 (2) 900  
(3) 300 (4) 150

39. A submarine is designed to withstand an absolute pressure of 100 atm. How deep can it go below the water surface ?

(Consider the density of water =  $1000 \text{ kg m}^{-3}$ ,  
 $1 \text{ atm} = 1 \times 10^5 \text{ Pa}$  and gravitational acceleration  
 $g = 10 \text{ m/s}^2$ )

- (1) 9900 m (2) 99 m  
(3) 9000 m (4) 990 m

40. Match List I with List II :

**List I**

(Electromagnetic wave)

A. Microwave

B. Visible light

C. Gamma rays

D. Infra-red rays

**List II**

(Production)

I. Electrons in atoms emit light when they move from a higher energy level to a lower energy level

II. Radioactive decay of nucleus

III. Vibration of atoms and molecules

IV. Klystron valve or magnetron valve

Choose the **correct** answer from the options given below :

(1) A-III, B-I, C-II, D-IV

(2) A-III, B-IV, C-I, D-II

(3) A-IV, B-III, C-II, D-I

(4) A-IV, B-I, C-II, D-III

41. Which of the following statements are correct ?

A. Inside a conductor, the electrostatic field is zero.

B. Electric field at the surface of a charged conductor does not depend on its surface charge density.

C. The interior of a charged conductor can have no excess charge in the static situation.

D. At the surface of a charged conductor, the electrostatic field must be normal to the surface at every point.

E. The electrostatic potential is zero everywhere inside a charged conductor.

Choose the **correct** answer from the options given below :

(1) C, D and E only

(2) A, B and D only

(3) A, C and D only

(4) A, C and E only

42. For a metal of work function 6.6 eV, which of the following wavelengths of incident radiation does **not** give rise to the photoelectric effect ?

(Take Planck's constant as  $6.6 \times 10^{-34}$  J s)

(1) 200 nm

(2) 150 nm

(3) 100 nm

(4) 50 nm

43. In the first excited state of hydrogen atom, the energy of its electron is -3.4 eV. The radial distance of the electron from the hydrogen nucleus in this case is approximately :

(Take  $1 \text{ eV} = 1.6 \times 10^{-19}$  J,  $e = 1.6 \times 10^{-19}$  C and

$$\frac{1}{4\pi\epsilon_0} = 9 \times 10^9 \text{ N m}^2/\text{C}^2)$$

(1)  $2.1 \times 10^{-8}$  m

(2)  $2.1 \times 10^{-11}$  m

(3)  $2.1 \times 10^{-9}$  m

(4)  $2.1 \times 10^{-10}$  m

44. Two statements are given below :

A. When the forward bias voltage across a p-n junction diode increases above a certain threshold voltage, the diode current increases significantly.

B. This current is called reverse saturation current.

Choose the **correct** answer from the options given below :

(1) Both Statements A and B are false

(2) Statement A is true, but Statement B is false

(3) Both Statements A and B are true

(4) Statement A is false, but Statement B is true

45. A flask contains argon and chlorine in the ratio of 2 : 1 by mass. The temperature of the mixture is  $27^\circ\text{C}$ . The ratio of root mean square speed of the

molecules of the two gases  $\left(\frac{v_{\text{rms}}^{\text{Ar}}}{v_{\text{rms}}^{\text{Cl}}}\right)$  is :

(Atomic mass of argon = 40.0 u and molecular mass of chlorine = 70.0 u)

(1)  $\frac{\sqrt{7}}{2}$

(2)  $\frac{7}{2}$

(3)  $\frac{7}{4}$

(4)  $\frac{2}{\sqrt{7}}$

46. Match List I with List II :

| List I |  | List II |  |
|--------|--|---------|--|
| A      |  | I       | (i) oleum,<br>(ii) NaOH, Δ,<br>(iii) H <sup>+</sup>                                    |
| B      | $\text{CH}_3\text{COOH} \rightarrow \text{CH}_3\text{CH}_2\text{OH}$ | II      | (i) O <sub>2</sub> ;<br>(ii) H <sub>2</sub> OH <sup>+</sup>                            |
| C      | $\text{CH}_3\text{CH}_2\text{CH}_2\text{OH} \rightarrow$<br>         | III     | (i) CH <sub>3</sub> OH, H <sup>+</sup> ;<br>(ii) H <sub>2</sub> , catalyst             |
| D      |  | IV      | (i) conc. H <sub>2</sub> SO <sub>4</sub> , Δ;<br>(ii) H <sup>+</sup> /H <sub>2</sub> O |

Choose the **correct** answer from the options given below :

- (1) A-I, B-III, C-IV, D-II
- (2) A-II, B-IV, C-III, D-I
- (3) A-II, B-III, C-I, D-IV
- ~~(4) A-II, B-III, C-IV, D-I~~

47. The major product Z formed in the following sequence of reactions is :

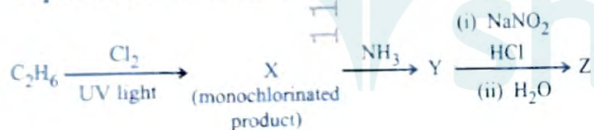

- (1) C<sub>2</sub>H<sub>5</sub>-N=N-OH
- ~~(2) C<sub>2</sub>H<sub>5</sub>OH~~
- ~~(3) C<sub>2</sub>H<sub>5</sub>NO<sub>2</sub>~~
- (4) C<sub>2</sub>H<sub>5</sub>NH<sub>2</sub>

48. In a qualitative analysis, Bi<sup>3+</sup> is detected by appearance of precipitate of BiO(OH)(s). Calculate pH when the following equilibrium exists at 298 K :



$$K = 4 \times 10^{-10}$$

(Given : log 2 = 0.3010)

- (1) 4.699
- (2) 8.714
- (3) 9.301
- (4) 5.286

49. When 1 dm<sup>3</sup> of CO<sub>2</sub> gas is passed over hot coke, the volume of gaseous mixture after complete reaction at STP becomes 1.4 dm<sup>3</sup>. The composition of the gaseous mixture at STP is :

- (1) 0.6 dm<sup>3</sup> of CO, 0.8 dm<sup>3</sup> of CO<sub>2</sub>
- (2) 0.8 dm<sup>3</sup> of CO, 0.8 dm<sup>3</sup> of CO<sub>2</sub>
- (3) 0.8 dm<sup>3</sup> of CO, 0.6 dm<sup>3</sup> of CO<sub>2</sub>
- (4) 0.6 dm<sup>3</sup> of CO, 0.4 dm<sup>3</sup> of CO<sub>2</sub>

50. Match List I with List II :

| List I<br>(Quantum Numbers) |     | List II<br>(Orbital) |    |
|-----------------------------|-----|----------------------|----|
| 'n'                         | 'l' |                      |    |
| A. 2                        | 1   | I.                   | 3d |
| B. 4                        | 0   | II.                  | 2p |
| C. 5                        | 3   | III.                 | 4s |
| D. 3                        | 2   | IV.                  | 5f |

Choose the **correct** answer from the options given below :

- ~~(1) A-II, B-III, C-IV, D-I~~
- (2) A-I, B-II, C-III, D-IV
- (3) A-IV, B-II, C-III, D-I
- (4) A-II, B-III, C-I, D-IV

51. The number of chlorine atoms present in the organic products X and Y of the following reactions, respectively, are

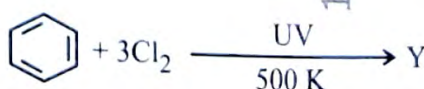
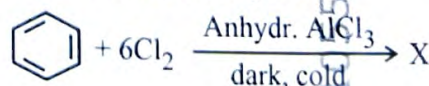

- (1) 3 and 6
- (2) 6 and 6
- ~~(3) 6 and 3~~
- (4) 3 and 3

52. In the following reaction sequence, X and Z, respectively are :

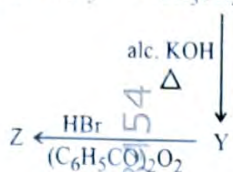

- (1)  $\text{X} = \text{POCl}_3$ ;  $\text{Z} = \text{CH}_3\text{-CH(Br)-CH}_3$
- (2)  $\text{X} = \text{H}_3\text{PO}_3$ ;  $\text{Z} = \text{CH}_3\text{CH}_2\text{CH}_2\text{-Br}$
- (3)  $\text{X} = \text{H}_3\text{PO}_3$ ;  $\text{Z} = \text{CH}_3\text{-CH(Br)-CH}_3$
- (4)  $\text{X} = \text{POCl}_3$ ;  $\text{Z} = \text{CH}_3\text{CH}_2\text{CH}_2\text{-Br}$

53. Match List I with List II :

List I

(Transition metal/  
compound/  
complex)

- A.  $\text{V}_2\text{O}_5$
- B. Fe
- C.  $\text{PdCl}_2$
- D. Ni complex

List II

(Catalytic Role)

- I. Preparation of ammonia from  $\text{N}_2/\text{H}_2$  mixture
- II. Polymerisation of alkynes
- III. Preparation of  $\text{H}_2\text{SO}_4$  from  $\text{SO}_2$
- IV. Oxidation of ethyne to ethanal

Choose the correct answer from the options given below :

- (1) A-III, B-IV, C-I, D-II
- (2) A-II, B-I, C-IV, D-III
- (3) A-IV, B-I, C-III, D-II
- (4) A-III, B-I, C-IV, D-II

54. Identify the correct statement about  $\text{ClF}_3$  from the following options :

- (1) It has a trigonal pyramidal geometry with two lone pairs on Cl atom.
- (2) It has T-shaped geometry with two lone pairs on Cl atom.
- (3) It has a planar trigonal geometry with two lone pairs on Cl atom.
- (4) It has T-shaped geometry with three lone pairs on Cl atom.

55. Calculate emf of the half cell given below :

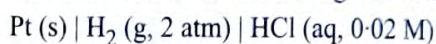

$$E^\circ_{\text{H}_2/\text{H}^+} = 0 \text{ V}$$

$$\left(\text{Given : } \frac{2 \cdot 303 RT}{F} = 0.059,\right.$$

$$\log 2 = 0.3010)$$

- (1) 0.109 V
- (2) 0.035 V
- (3) -0.035 V
- (4) 0.109 V

56. Match List I with List II :

List I

(Order of reaction)

- A. Zero order
- B. First order
- C. Second order
- D. Third order

List II

(Unit of rate constant)

- I.  $\text{mol}^{-1} \text{L s}^{-1}$
- II.  $\text{mol}^{-2} \text{L}^2 \text{s}^{-1}$
- III.  $\text{s}^{-1}$
- IV.  $\text{mol L}^{-1} \text{s}^{-1}$

Choose the correct answer from the options given below :

- (1) A-IV, B-III, C-II, D-I
- (2) A-I, B-II, C-III, D-IV
- (3) A-IV, B-III, C-I, D-II
- (4) A-IV, B-II, C-I, D-III

57. The calculated 'spin-only' magnetic moment of

$Ti^{2+}(3d^2)$  is :

- (1) 2.84 BM (2) 5.92 BM  
(3) 4.90 BM (4) 3.87 BM

58. Two products X and Y are formed in the following reaction sequence.

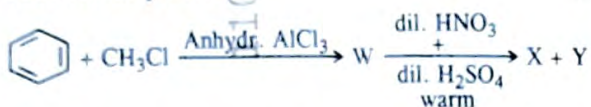

The suitable method that can be used for the separation of products X and Y is :

- (1) Continuous extraction  
(2) Differential extraction  
(3) Fractional distillation  
(4) Sublimation

59. A bulb is rated at 150 watt, converting 8% energy into light. If energy of one photon is  $4.42 \times 10^{-19}$  J, how many photons are emitted by the bulb per second ?

- (1)  $1.35 \times 10^{19}$  (2)  $4.06 \times 10^{19}$   
(3)  $2.71 \times 10^{19}$  (4)  $27.2 \times 10^{19}$

60. In a test tube containing a salt, a few drops of dilute  $\text{H}_2\text{SO}_4$  was added, which gave colourless vapours having the smell of vinegar. The vapours turned the blue litmus paper red.

Identify the **correct** anion from the following :

- (1) Acetate,  $\text{CH}_3\text{COO}^-$   
(2) Carbonate,  $\text{CO}_3^{2-}$   
(3) Sulphate,  $\text{SO}_4^{2-}$   
(4) Sulphide,  $\text{S}^{2-}$

61. Select the reagents that reduce nitriles to primary amines :

- A. (i)  $\text{LiAlH}_4$ ; (ii)  $\text{H}_2\text{O}$   
B.  $\text{Sn} + \text{HCl}$   
C.  $\text{H}_2/\text{Ni}$   
D.  $\text{Na(Hg)}/\text{C}_2\text{H}_5\text{OH}$   
E.  $\text{Br}_2/\text{aq. NaOH}$

Choose the **correct** answer from the options given below :

- (1) A, B and C only  
(2) A, C and D only  
(3) A, D and E only  
(4) B, D and E only

62. Identify the **incorrect** statement from the following :

- (1) Carbon has the ability to form  $p\pi-p\pi$  multiple bond with itself.  
(2)  $\text{ECl}_3$  (E = B and Al) is a monomer when E = B and a dimer when E = Al.  
(3) Oxygen exhibits only -2 oxidation state.  
(4) The order of catenation property of Group 14 elements is  $\text{C} \gg \text{Si} > \text{Ge} \approx \text{Sn}$ .

63. Although +3 oxidation state is most common in lanthanoids, cerium still shows +4 oxidation state because :

- (1) Its nearest inert gas is Radon.  
(2) After losing one more electron, it acquires  $4f^{14}$  electronic configuration.  
(3) Its atomic number is 61.  
(4) After losing one more electron, it acquires  $4f^0$  electronic configuration.

$$\frac{5.6}{60}$$

$$\frac{5.6}{60} \times 6.023 \times 10^{23}$$

$$\frac{5.6}{60} \times N_A =$$

NaOH

64. During Lassaigne's test, the elements present in an organic compound are converted from :

- (1) covalent form to covalent form
- (2) ionic form to ionic form
- ~~(3) covalent form to ionic form~~
- (4) ionic form to covalent form

65. The number of hydrogen atoms present in 5.4 g of urea is :

(Given : Molar mass of urea :  $60 \text{ g mol}^{-1}$ ,

$N_A : 6.022 \times 10^{23} \text{ particles mol}^{-1}$ )

- (1)  $2.168 \times 10^{23}$
- ~~(2)  $2.168 \times 10^{22}$~~
- ~~(3)  $1.084 \times 10^{22}$~~
- (4)  $1.084 \times 10^{23}$

66. The pair of molecules that are metamers among the following is :

(1)  $\text{CH}_3\text{CH}_2\text{CH}_2\text{OH}$  and  $\text{CH}_3 - \text{CH}(\text{OH}) - \text{CH}_3$

~~(2)  $\text{CH}_3\text{OCH}_2\text{CH}_2\text{CH}_3$  and  $\text{CH}_3\text{CH}_2\text{OCH}_2\text{CH}_3$~~

(3)  $\text{H}_3\text{C} - \overset{\text{O}}{\parallel} \text{C} - \text{CH}_3$  and  $\text{H}_3\text{C} - \text{CH}_2 - \overset{\text{O}}{\parallel} \text{C} - \text{H}$

(4)  $\text{CH}_3\text{CH}_2\text{CH}_2\text{CH}_2\text{CH}_3$  and

$(\text{CH}_3)_2\text{CHCH}_2\text{CH}_3$

67. Identify the **incorrect** statement from the following :

- (1)  $\text{P}(\text{C}_2\text{H}_5)_3$  and  $\text{As}(\text{C}_6\text{H}_5)_3$  form  $d\pi-d\pi$  bond with transition metals.
- (2) Nitrogen can form  $d\pi-p\pi$  bond with oxygen.
- (3) Nitrogen can form  $p\pi-p\pi$  multiple bonds with itself.
- (4) Phosphorus, arsenic and antimony show catenation property.

68. Phenolphthalein is used as an indicator for the titration of sodium hydroxide solution against a standard solution of oxalic acid. The colour change that is observed at an alkaline pH close to the equivalence point during this titration is :

- ~~(1) pinkish red to yellow~~
- (2) yellow to pinkish red
- (3) colourless to pink
- (4) pink to colourless

69. Match List I with List II :

**List I**

**List II**

- |                           |                                     |
|---------------------------|-------------------------------------|
| A. $\text{C}_2\text{H}_4$ | I. $3 \sigma$ bonds, $2 \pi$ bonds  |
| B. $\text{C}_2\text{H}_2$ | II. $3 \sigma$ bonds, one lone pair |
| C. $\text{CH}_4$          | III. $4 \sigma$ bonds               |
| D. $\text{NH}_3$          | IV. $5 \sigma$ bonds, $1 \pi$ bond  |

Choose the **correct** answer from the options given

below :

- ~~(1) A-IV, B-I, C-III, D-II~~
- (2) A-III, B-IV, C-II, D-I
- (3) A-I, B-II, C-IV, D-III
- (4) A-II, B-III, C-I, D-IV

70. At a certain temperature, T (K), during a process, 500 J is absorbed by the system and work of 200 J is done by the system. Then change in internal energy of the system is :

- (1) 700 J
- (2) 300 J
- (3) 400 J
- (4) 500 J

71. Methane reacts with steam at 1273 K in the presence of nickel catalyst to form :

- ~~(1) CO and  $\text{H}_2$~~
- (2) CO and  $\text{H}_2\text{O}$
- (3)  $\text{CO}_2$  and  $\text{H}_2\text{O}$
- (4)  $\text{CO}_2$  and  $\text{H}_2$

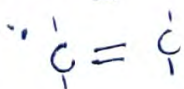

$$\Delta Q = \Delta U + \Delta W$$

$$\Delta U = \Delta Q + \Delta W$$

$$\Delta U = \Delta Q - \Delta W$$

$$300 - 200$$

72. Compound P (C<sub>8</sub>H<sub>8</sub>O) gives a red orange precipitate with 2,4-DNP reagent and it does not reduce Fehling's reagent. On drastic oxidation with chromic acid, P gives an aromatic product Q that produces effervescence on treating with aq. NaHCO<sub>3</sub>. Compounds P and Q, respectively, are :

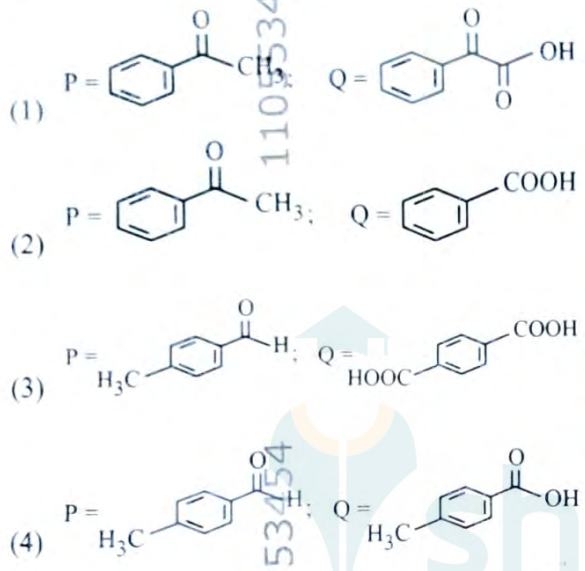

73. A solution of copper sulphate is electrolysed for 10 minutes with a current of 1.5 amperes. The mass of copper deposited at cathode is :

(Given : Molar mass of Cu = 63 g mol<sup>-1</sup>;  
1 F = 96487 C mol<sup>-1</sup>)

- (1) 2.4036 g      (2) 1.7018 g  
(3) 0.5876 g      (4) 0.2938 g

74. The functional group that can be identified through phthalein dye test is :

- (1) Phenolic  
(2) Alcohol  
(3) Aldehyde  
(4) Carboxylic acid

75. The correct statement with regard to the secondary structure of DNA/RNA is :

- (1) DNA possesses a single strand helix structure and contains uracil as one of the four bases.  
(2) RNA possesses a single strand helix structure and contains thymine as one of the four bases.  
(3) DNA possesses a double strand helix structure and contains thymine as one of the four bases.  
(4) RNA possesses a double strand helix structure and contains uracil as one of the four bases.

76. Identify the correct statements

- A. The molality of 2.5 g of ethanoic acid (Molar mass : 60 g mol<sup>-1</sup>) in 75 g of benzene solution is 0.556 m.  
B. The molarity of a solution containing 5 g of NaOH (molar mass : 40 g mol<sup>-1</sup>) in 450 mL of solution is 0.278 M at 298 K.  
C. Aquatic species are more comfortable in cold water.  
D. The solubility of gas increases with decrease in pressure.  
E. For a binary mixture of A and B, the number of moles of A and B are n<sub>A</sub> and n<sub>B</sub> respectively. The mole fraction of B will be  $x_B = \frac{n_A}{n_A + n_B}$ .

Choose the correct answer from the options given below :

- (1) A and C only  
(2) A, B and C only  
(3) A, D and E only  
(4) A and B only

77. Mixture of chloroform and acetone forms a solution with negative deviation from Raoult's law due to:

- (1) formation of hydrogen bonding between acetone and chloroform.
- (2) increase in escaping tendency of molecules of each component.
- (3) stronger intermolecular forces between chloroform molecules than those between chloroform and acetone molecules.
- (4) repulsive forces.

78. At 298 K, a certain buffer solution contains equal concentrations of  $X^-$  and  $HX$ ,  $K_b$  for  $X^-$  is  $10^{-10}$ .

What is the pH of this buffer solution?

- (1) 2
- (2) 10
- (3) 4
- (4) 6

79. Identify the **incorrect** statement from the following:

- (1) The IUPAC name of the element with atomic number 107 is Unnilseptium.
- ~~(2) The largest and the smallest species among  $Mg$ ,  $Mg^{2+}$ ,  $Al$  and  $Al^{3+}$  are  $Al$  and  $Mg^{2+}$ , respectively.~~
- (3) The similarity in behaviour of  $Li$  with  $Mg$  is referred to as 'diagonal relationship'.
- (4) The oxidation state and covalency of  $Al$  in  $[AlCl(H_2O)_5]^{2+}$  are 3 and 6 respectively.

80. The correct order of increasing metallic character of  $Na$ ,  $Be$ ,  $P$ ,  $Mg$  and  $Si$  is:

- ~~(1)  $P < Si < Be < Mg < Na$~~
- (2)  $Be < Si < P < Mg < Na$
- (3)  $P < Si < Na < Mg < Be$
- (4)  $P < Mg < Be < Si < Na$

81. The correct IUPAC name of the following compound is:

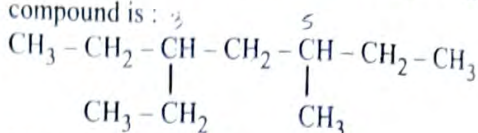

- (1) 2,4-diethylhexane
- (2) 3,5-diethylhexane
- ~~(3) 3-ethyl-5-methylheptane~~
- (4) 3-methyl-5-ethylheptane

82. Match List I with List II

List I

(Complex/ion)

- A.  $[Pt(Cl_2)(NH_3)_2]$
- B.  $[Co(NH_3)_6]Cl_3$
- C.  $[NiCl_4]^{2-}$
- D.  $[Fe(CO)_5]$

List II

(Shape/geometry)

- I. Octahedral
- II. Trigonal bipyramidal
- III. Square planar
- IV. Tetrahedral

Choose the **correct** answer from the options given below:

- (1) A-I, B-III, C-IV, D-II
- ~~(2) A-III, B-IV, C-I, D-II~~
- (3) A-IV, B-I, C-III, D-II
- (4) A-III, B-I, C-IV, D-II

83. For a certain reaction  $R \rightarrow \text{Product}$ , the plot of concentration  $[R]$  vs time has a negative slope as shown. The order of reaction is:

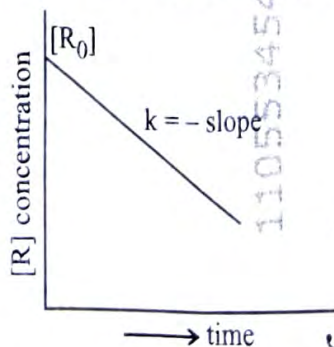

$$k = \frac{R - R_0}{t}$$

$$y = mx + c$$

- ~~(1) 0~~
- (3) 2
- (2) 1
- (4) 2.5

84. Which one of the following is an ambidentate ligand?

- (1) Ethylenediaminetetraacetate ion
- (2) Oxalate
- (3) Ethane-1,2-diamine
- (4) Thiocyanate

85. Consider the following reaction :

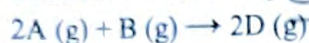

$$\Delta U^\ominus = -10 \text{ kJ mol}^{-1} \text{ and } \Delta S^\ominus = -44 \text{ J K}^{-1} \text{ at } 298 \text{ K.}$$

Identify the correct option with  $\Delta G^\ominus$  for the reaction and spontaneity of the reaction at 298 K.

$$\text{(Given : } R = 8.31 \text{ J mol}^{-1} \text{ K}^{-1}\text{)}$$

- (1)  $-1.635 \text{ kJ mol}^{-1}$ , spontaneous
- (2)  $+0.63568 \text{ kJ mol}^{-1}$ , non-spontaneous
- (3)  $-0.63568 \text{ kJ mol}^{-1}$ , spontaneous
- (4)  $+1.635 \text{ kJ mol}^{-1}$ , non-spontaneous

86.

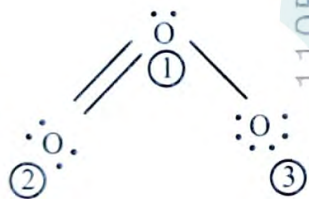

The correct formal charges on oxygen atoms numbered 2, 1 and 3 respectively are :

- (1)  $-1, 0, +1$
- (2)  $0, +1, -1$
- (3)  $0, 0, 0$
- (4)  $+1, 0, -1$

87. Given below are certain reactions. Identify the reaction for which  $K_p \neq K_c$ .

- (1)  $H_2(g) + I_2(g) \rightleftharpoons 2HI(g)$
- (2)  $N_2(g) + O_2(g) \rightleftharpoons 2NO(g)$
- (3)  $N_2(g) + 3H_2(g) \rightleftharpoons 2NH_3(g)$   $2-6-2$
- (4)  $H_2O(g) + CO(g) \rightleftharpoons H_2(g) + CO_2(g)$

88. Given below is an expression for the rate constant of a first order reaction occurring at a certain temperature, T (K).

$$\ln k = 14.34 - \frac{1.25 \times 10^4}{T}$$

The energy of activation in  $\text{kcal mol}^{-1}$  for the reaction is :

$$\text{(Given : } k \text{ in s}^{-1}\text{, } R = 1.987 \text{ cal mol}^{-1} \text{ K}^{-1}\text{)}$$

- (1) 12.42
- (2) 14.34
- (3) 18.63
- (4) 24.84

89. The following two reactions give the same foul smelling product Z.

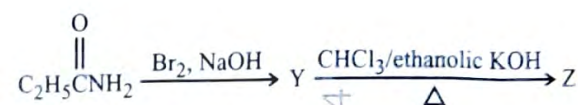

X and Z, respectively, are

- (1)  $X = AgCN$ ;  $Z = C_2H_5CN$
- (2)  $X = KCN$ ;  $Z = C_2H_5CN$
- (3)  $X = KCN$ ;  $Z = C_2H_5NC$
- (4)  $X = AgCN$ ;  $Z = C_2H_5NC$

90. Match List I with List II :

**List I**  
(Complex)

**List II**  
(Type of isomerism)

- |                           |      |             |
|---------------------------|------|-------------|
| A. $[Pt(NH_3)_2Cl_2]$     | I.   | Optical     |
| B. $[Co(en)_3]^{3+}$      | II.  | Solvate     |
| C. $[Co(NH_3)_5NO_2]Cl_2$ | III. | Geometrical |
| D. $[Cr(H_2O)_6]Cl_3$     | IV.  | Linkage     |

Choose the correct answer from the options given below :

- (1) A-III, B-I, C-II, D-IV
- (2) A-I, B-III, C-II, D-IV
- (3) A-III, B-I, C-IV, D-II
- (4) A-II, B-IV, C-III, D-I

91. "The Evil Quartet" of biodiversity loss includes which of the following ?

- (1) Over-exploitation; Alien species invasions; Air pollution; Co-extinctions  
~~(2) Habitat loss and fragmentation; over-exploitation; Alien species invasions; Co-extinctions~~  
 (3) Habitat loss and fragmentation; Air pollution; Water pollution; Co-extinctions  
 (4) Over-exploitation; Alien species invasions; Soil pollution; Co-extinctions

92. Which one of the following is the site for active ribosomal RNA synthesis ?

- ~~(1) Nucleolus~~ (2) Chromatin  
 (3) Centrosome (4) Kinetochore

93. Match List I with List II :

| List I<br>(Phase of cell cycle) | List II<br>(Activity) |
|---------------------------------|-----------------------|
|---------------------------------|-----------------------|

- |                         |  |
|-------------------------|--|
| A. G <sub>1</sub> phase | I. Actual cell division occurs   |
| B. S phase              | II. Cell is metabolically active and continuously grows but does not replicate its DNA |
| C. G <sub>2</sub> phase | III. Synthesis of DNA occurs and the amount of DNA per cell doubles                    |
| D. M phase              | IV. Proteins are synthesized while cell growth continues                               |

Choose the **correct** answer from the options given below :

- ~~(1) A-II, B-III, C-IV, D-I~~  
 (2) A-III, B-IV, C-I, D-II  
 (3) A-I, B-II, C-III, D-IV  
 (4) A-IV, B-I, C-II, D-III

94. Match List I with List II :

**List I**

**List II**

- |                               |  |
|-------------------------------|--|
| A. Productivity               | I. Gross primary productivity minus respiration losses         |
| B. Net primary productivity   | II. Rate of formation of new organic matter by consumers       |
| C. Gross primary productivity | III. Rate of biomass production                                |
| D. Secondary productivity     | IV. Rate of production of organic matter during photosynthesis |

Choose the **correct** answer from the options given below :

- (1) A-I, B-II, C-III, D-IV  
~~(2) A-III, B-I, C-IV, D-II~~  
 (3) A-III, B-I, C-II, D-IV  
 (4) A-I, B-III, C-IV, D-II

95. Which of the following statements are correct ?

- A. The Amazon rainforest being cut and cleared for cultivation of soyabeans is an example of habitat loss.  
 B. Steller's sea cow and passenger pigeon became extinct due to over-exploitation by humans.  
 C. The Nile perch introduced into Lake Victoria in East Africa helped in population growth of cichlid fish in the lake.  
 D. Water hyacinth is an invasive species.  
 E. When a species becomes extinct, the plant and animal species associated with it are not affected.

Choose the **correct** answer from the options given below :

- (1) B, C and D only  
~~(2) A, B and D only~~  
 (3) A, B and E only  
 (4) C, D and E only

96. Identify the correct statements about biomolecules.

- A. Lipids are generally water soluble.
- B. Proteins are polypeptides.
- C. Polysaccharides are long chains of sugars.
- D. Adenine and guanine are substituted pyrimidines.
- E. Almost all enzymes are proteins.

Choose the **correct** answer from the options given below :

- (1) C, D and E only
- (2) B, C and E only
- (3) B, D and E only
- (4) A, B and C only

97. How many ATP and NADPH molecules are required to make one molecule of glucose through the Calvin pathway ?

- (1) 18 ATP and 12 NADPH
- (2) 6 ATP and 12 NADPH
- (3) 24 ATP and 18 NADPH
- ~~(4)~~ 12 ATP and 18 NADPH

98. Which of the following statements are **not** true regarding restriction endonucleases ?

- A. They are called molecular scissors.
- B. These are the enzymes responsible for restricting the growth of bacteriophages in *E. coli*.
- C. They cut the DNA only at the centre of the palindromic sites.
- D. They remove nucleotides only from the ends of DNA fragments.
- E. They recognise specific palindromic base-pair sequences.

Choose the answer from the options given below :

- (1) A and B only
- (2) D and E only
- (3) C and D only
- ~~(4)~~ A and E only

99. Match List I with List II :

**List I**

- A. Decomposition
- B. Detritus
- C. Mineralisation
- D. Humification

**List II**

- I. Accumulation of dark coloured amorphous colloidal substance
- II. Release of inorganic nutrients by the activity of microbes in soil
- III. Breaking down of complex organic matter into inorganic substances
- IV. Dead remains of plants and animals including fecal matter

Choose the **correct** answer from the options given below :

- (1) A-I, B-II, C-III, D-IV
- (2) A-IV, B-III, C-I, D-II
- ~~(3)~~ A-III, B-IV, C-II, D-I
- (4) A-III, B-II, C-I, D-IV

100. In which one of the following, the ovules are **not** enclosed by an ovary wall and remain exposed ?

- (1) *Selaginella*
- (2) *Funaria*
- ~~(3)~~ *Pinus*
- (4) *Wolffia*

101. Match List I with List II :

**List I**

**(Placentation)**

- A. Marginal
- B. Axile
- C. Parietal
- D. Basal

**List II**

**(Example)**

- I. Mustard
- II. Pea
- III. Marigold
- IV. Lemon

Choose the **correct** answer from the options given below :

- (1) A-I, B-III, C-II, D-IV
- (2) A-IV, B-II, C-I, D-III
- ~~(3)~~ A-II, B-IV, C-I, D-III
- (4) A-III, B-I, C-IV, D-II

102. In angiosperms, root hairs arise from which one of the following regions of the root ?

- (1) The root cap zone
- (2) The region of meristematic activity
- (3) The region of elongation
- (4) The region of maturation

103. Which one of the following is **not** a characteristic of plant cells in the phase of elongation ?

- (1) Increased vacuolation
- (2) Large conspicuous nuclei
- (3) Cell enlargement
- (4) New cell wall deposition

104. Which of the following statements are correct with reference to a transcription unit ?

- A. A transcription unit in DNA is defined primarily by three regions : promoter, structural gene and terminator.
- B. The promoter is said to be located towards the 5'-end of the structural gene.
- C. The promoter is a DNA sequence that provides binding site for RNA polymerase.
- D. The promoter defines the template and coding strands.
- E. The terminator is located towards the 3'-end of the coding strand and it defines the end of the process of transcription.

Choose the **correct** answer from the options given below :

- (1) A, B, C, D and E
- (2) B, C, D and E only
- (3) A, C, D and E only
- (4) A, B, C and D only

105. Alpha-helix is found in which level of protein structure ?

- (1) Quaternary structure
- (2) Tertiary structure
- (3) Primary structure
- (4) Secondary structure

106. Which of the following statements are correct regarding amino acids ?

- A. They are substituted methanes.
- B. Serine is an aromatic amino acid.
- C. Valine is a neutral amino acid.
- D. Lysine is an acidic amino acid.

Choose the **correct** answer from the options given below :

- (1) C and D only
- (2) A and B only
- (3) A and C only
- (4) B and C only

107. The main function of bulliform cells in grasses is :

- (1) to make the leaf impermeable to fungal spores.
- (2) to perform photosynthesis.
- (3) to minimize water loss during water stress.
- (4) to transport water.

108. Find the **incorrect** statement(s) about photosynthesis from the following :

- A. The water splitting complex is associated with PS I.
- B.  $C_4$  plants use the  $C_3$  pathway of  $CO_2$  fixation as the main biosynthetic pathway.
- C. In  $C_4$  plants, photorespiration does not occur.
- D.  $C_3$  plants exhibit 'Kranz' anatomy.
- E. ATP synthesis in chloroplast occurs through chemiosmosis.

Choose the answer from the options given below :

- (1) B only
- (2) A and D only
- (3) B and C only
- (4) B and E only

109. Match List I with List II :

| List I                | List II   |
|-----------------------|---|
| A. Conjunctive tissue | I. Specialised cells in the vicinity of guard cells |
| B. Casparian strips   | II. Endodermal cells rich in starch                 |
| C. Subsidiary cells   | III. Tissue between xylem and phloem                |
| D. Starch sheath      | IV. Endodermal cells with suberin deposition        |

Choose the **correct** answer from the options given below :

- (1) A-IV, B-III, C-I, D-II
- (2) A-III, B-IV, C-II, D-I
- (3) A-III, B-IV, C-I, D-II
- (4) A-IV, B-III, C-II, D-I

110. Match List I with List II :

| List I                           | List II                             |
|----------------------------------|-------------------------------------|
| A. Genetically modified organism | I. <i>Agrobacterium tumefaciens</i> |
| B. Thermostable DNA polymerase   | II. Bt cotton                       |
| C. Ti plasmid                    | III. <i>Thermus aquaticus</i>       |
| D. pBR322                        | IV. <i>Escherichia coli</i>         |

Choose the **correct** answer from the options given below :

- (1) A-II, B-I, C-IV, D-III
- (2) A-I, B-IV, C-III, D-II
- (3) A-II, B-III, C-I, D-IV
- (4) A-I, B-II, C-IV, D-III

111. Heterophyllous development in response to environment is an example of which of the following phenomena ?

- (1) Dedifferentiation
- (2) Elasticity
- (3) Redifferentiation
- (4) Plasticity

112. In racemose inflorescence, \_\_\_\_\_

- (1) the main axis terminates in a flower
- (2) the growth is limited
- (3) flowers are borne in an acropetal succession
- (4) flowers are solitary

113. Which one of the following disorders is caused by the substitution of Glutamic acid (Glu) by Valine (Val) at the sixth position of the beta globin chain of the haemoglobin molecule ?

- (1) Haemophilia
- (2) Thalassemia
- (3) Sickle-cell anaemia
- (4) Phenylketonuria

114. Match List I with List II :

| List I                   | List II  |
|--------------------------|--|
| A. Incomplete dominance  | I. Human skin colour                                       |
| B. Co-dominance          | II. Inheritance of flower colour in <i>Antirrhinum</i> sp. |
| C. Pleiotropy            | III. Phenylketonuria disease in humans                     |
| D. Polygenic inheritance | IV. ABO blood groups                                       |

Choose the **correct** answer from the options given below :

- (1) A-II, B-IV, C-III, D-I
- (2) A-I, B-III, C-II, D-IV
- (3) A-II, B-I, C-III, D-IV
- (4) A-I, B-IV, C-III, D-II

115. Arrange the following in the correct developmental sequence related to microsporogenesis :

- A. Microspore tetrads
- B. Sporogenous tissue
- C. Pollen grains
- D. Pollen mother cells

Choose the **correct** answer from the options given below :

- (1) D, A, C, B
- (3) B, D, A, C
- (2) B, D, C, A
- (4) A, D, C, B

116. Arrange the following steps of DNA fingerprinting in a correct sequence.

- A. Isolation of DNA and its digestion by restriction endonucleases.
- B. Hybridisation using a labelled VNTR probe.
- C. Transferring of separated DNA fragments to synthetic membranes.
- D. Detection of hybridised DNA fragments by autoradiography.
- E. Separation of DNA fragments by electrophoresis.

Choose the **correct** answer from the options given below :

- (1) A, E, C, B, D
- (2) A, E, B, C, D
- (3) A, B, D, C, E
- (4) A, D, B, E, C

117. Exploring molecular, genetic and species-level diversity for products of economic importance is called :

- (1) Biomagnification
- (2) Biofortification
- (3) Bioremediation
- (4) Bioprospecting

118. Which of the following statements are true with reference to the sex-determination in honeybees ?

- A. An offspring formed from the union of a sperm and an egg, develops as a female (queen or worker).
- B. An unfertilized egg develops as a male by parthenogenesis.
- C. A male has half the number of chromosomes than that of a female.
- D. Males produce sperms by meiosis.
- E. Honeybees have a haplodiploid sex-determination system.

Choose the **correct** answer from the options given below :

- (1) B, C, D and E only
- (2) A, B, C and D only
- (3) A, B, D and E only
- (4) A, B, C and E only

119. Identify the **correct** sequence of steps in each cycle of Polymerase Chain Reaction :

- (1) Denaturation → Annealing → Extension
- (2) Denaturation → Extension → Annealing
- (3) Extension → Annealing → Denaturation
- (4) Annealing → Denaturation → Extension

120. Which of the following statements are correct with respect to DNA separation, isolation and visualization ?

- A. The cutting of DNA is done by molecular scissors.
- B. The DNA fragments separate according to their size in an agarose gel, upon electrophoresis.
- C. The separated DNA fragments can be seen without staining when exposed to UV light.
- D. The separated DNA fragments, when stained with ethidium bromide, can be seen in visible light.

Choose the **correct** answer from the options given below :

- (1) A and D only
- (2) B and D only
- (3) B and C only
- (4) A and B only

121. The main criteria used for Five Kingdom Classification proposed by R.H. Whittaker (1969) included :

- A. Cell structure
- B. Body organization
- C. Presence of flagellum
- D. Reproduction
- E. Phylogenetic relationships

Choose the **correct** answer from the options given below :

- (1) A, B, D and E only
- (2) A, B, C, D and E
- (3) A, B and E only
- (4) B, C and D only

122. Which one of the following is a triploid cell ?

- (1) Central cell
- (2) Primary endosperm cell
- (3) Zygote
- (4) Synergid

123. Which of the following statements are correct with reference to packaging of DNA helix ?

- A. Histones are organized to form a unit of eight molecules called histone octamer.
- B. Histones are negatively charged basic proteins.
- C. Histones are rich in the basic amino acid residues – lysine and arginine.
- D. The positively charged DNA is wrapped around the histone octamer to form nucleosome.
- E. The packaging of chromatin at higher levels requires an additional set of proteins called non-histone chromosomal proteins.

Choose the **correct** answer from the options given below :

- (1) A, B and D only
- (2) A, C and E only
- (3) C, D and E only
- (4) B, D and E only

124. Which of the following is an *in situ* conservation method ?

- (1) Sacred Groves
- (2) Wildlife Safari Parks
- (3) Botanical Gardens
- (4) Seed Banks

125. In the *lac* operon, the *z* gene codes for :

- (1) transacetylase
- (2) the repressor of *lac* operon
- (3) permease
- (4) beta-galactosidase

126. Match List I with List II :

**List I**  
(Growth Regulator)

**List II**  
(Function/Effect)

- A. 2,4-D
- B. GA<sub>3</sub>

- I. Brewing industry
- II. Stimulation of stomatal closure

- C. Kinetin
- D. ABA

- III. Herbicide
- IV. Nutrient mobilisation

Choose the **correct** answer from the options given below :

- (1) A-IV, B-III, C-II, D-I
- (2) A-I, B-II, C-IV, D-III
- (3) A-III, B-I, C-IV, D-II
- (4) A-I, B-IV, C-III, D-II

127. Arrange the following steps of somatic hybridisation in a correct sequence.

- A. Digestion of cell walls.
- B. Isolation of naked protoplasts.
- C. Fusion of protoplasts to get hybrid protoplast.
- D. Isolation of single cells from two different varieties of plants.
- E. Growing of hybrid protoplast to form a new plant.

Choose the **correct** answer from the options given below :

- (1) E, A, B, C, D
- (2) D, A, B, C, E
- (3) E, B, A, D, C
- (4) D, B, A, E, C

128.  $2(C_{51}H_{98}O_6) + 145 O_2 \rightarrow$



The Respiratory Quotient (RQ) of a biomolecule used for respiration, as per the above equation, would be :

- (1) Less than 0.5
- (2) Between 0.5 and 0.95
- (3) Between 1.25 and 2
- (4) 1.0

129. Since the origin and diversification of life on Earth, there have been five episodes of mass extinction of species. How is the sixth extinction, which is in progress, different from the previous episodes ?

- (1) The current species extinction rates are far lower than those in previous episodes.
- (2) The present species extinction rates are 100 to 1000 times faster than in the pre-human times.
- (3) The present net species extinction rate is zero.
- (4) The current species extinction rate is nearly 10 times faster than that in previous episodes.

130. Match List I with List II :

**List I**

- A. Trypsin
- B. Morphine
- C. Concanavalin A
- D. Collagen

**List II**

- I. Intercellular ground substance
- II. Lectin
- III. Enzyme
- IV. Alkaloid

Choose the **correct** answer from the options given below :

- (1) A-III, B-IV, C-II, D-I
- (2) A-I, B-II, C-III, D-IV
- (3) A-III, B-II, C-IV, D-I
- (4) A-IV, B-III, C-II, D-I

131. Which one of the following statements is **not** true about the universal rules of binomial nomenclature ?

- (1) Both the words in a biological name, when handwritten, are separately underlined or printed in italics.
- (2) The specific epithet in the biological name starts with a small letter.
- (3) The first word in the biological name represents the specific epithet, while the second component denotes the genus.
- (4) Biological names are generally in Latin.

132. The enzyme required for carboxylation in the Calvin cycle is :

- (1) PEP carboxylase
- (2) RuBP carboxylase – oxygenase
- (3) Carboxypeptidase
- (4) Hexokinase

133. Which of the following floral formula is the correct floral formula of Solanaceae family ?

- (1)  $\overset{\oplus}{\underset{\ominus}{\text{K}}}_5 \overset{\frown}{\text{C}}_{(5)} \text{A}_5 \underline{\text{G}}_{(2)}$
- (2)  $\overset{\oplus}{\underset{\ominus}{\text{K}}}_5 \overset{\frown}{\text{C}}_{(5)} \text{A}_5 \underline{\text{G}}_{(2)}$
- (3)  $\overset{\oplus}{\underset{\ominus}{\text{K}}}_5 \text{C}_{(5)} \text{A}_5 \underline{\text{G}}_{(2)}$
- (4)  $\overset{\oplus}{\underset{\ominus}{\text{K}}}_5 \text{C}_5 \text{A}_5 \underline{\text{G}}_{(2)}$

134. Which one of the following types of pollination brings genetically different types of pollen grains to the stigma ?

- (1) Geitonogamy
- (2) Autogamy
- (3) Xenogamy
- (4) Cleistogamy

135. Match List I with List II :

**List I**

**(Process)**

- A. Glycolysis
- B. ETS
- C. Accumulation of protons
- D. Krebs' cycle

**List II**

**(Location)**

- I. Inner mitochondrial membrane
- II. Mitochondrial matrix
- III. Cytoplasm
- IV. Intermembrane space

Choose the **correct** answer from the options given below :

- (1) A-I, B-IV, C-III, D-II
- (2) A-III, B-I, C-IV, D-II
- (3) A-IV, B-II, C-I, D-III
- (4) A-II, B-III, C-IV, D-I

DR SNEHA  
DR MENA

136. Insertion of a foreign DNA at BamHI site in an *E. coli* cloning vector pBR322 results in the loss of antibiotic resistance towards :

- (1) Gentamycin
- (2) Ampicillin and tetracycline
- (3) Tetracycline
- (4) Ampicillin

137. The sixth mutant codon of beta globin gene causing polymerization of Haemoglobin and change in RBC shape is \_\_\_\_\_.

- (1) CAG
- (2) GUG
- (3) AUG
- (4) GAG

138. Choose the correct statement regarding GIFT to overcome infertility.

- (1) Ova collected from a female donor are transferred to the uterus of an infertile female.
- (2) It is the transfer of an ovum collected from a donor into the fallopian tube of another female who cannot produce ovum but can provide suitable environment for fertilization and development.
- (3) Early embryos with up to 8 blastomeres are transferred to the uterus of an infertile female.
- (4) Early embryos with up to 8 blastomeres are transferred into the fallopian tube of an infertile female.

139. Which one of the following is an appropriate example of 'sexual deceit'?

- (1) Female wasp and fig
- (2) Cuckoo and crow
- (3) *Ophrys* and bumblebee
- (4) Sea anemone and clown fish

140. Evolution of human appears parallel to the progressive development of brain and language skills. As such, the evolution of individual species in the sequence of their appearance is :

- (1) *Homo habilis* → *Homo erectus* → *Ramapithecus* → Neanderthal → *Homo sapiens*
- (2) *Ramapithecus* → *Homo habilis* → *Homo erectus* → Neanderthal → *Homo sapiens*
- (3) *Homo sapiens* → *Ramapithecus* → *Homo habilis* → Neanderthal → *Homo erectus*
- (4) Neanderthal → *Ramapithecus* → *Homo habilis* → *Homo erectus* → *Homo sapiens*

141. Match List I with List II related to embryonic development at various months of pregnancy :

- | List I  | List II   |
|---|---|
| A. The foetus movement starts and hair appears on the head                              | I. 24 weeks of pregnancy                                      |
| B. The foetus develops limbs and digits   | <input checked="" type="checkbox"/> II. 20 weeks of pregnancy |
| C. The foetus develops external genital organs  | III. 8 weeks of pregnancy                                     |
| D. The foetus body is covered with fine hair; eyelids separate and eyelashes are formed | IV. 12 weeks of pregnancy                                     |

Choose the correct answer from the options given below :

- (1) A-III, B-II, C-IV, D-I
- (2) A-II, B-IV, C-III, D-I
- (3) A-IV, B-II, C-III, D-I
- (4) A-II, B-III, C-IV, D-I

142. A group of researchers procured some fish-like animals and upon investigation the following characters were observed :

- A. Endoskeleton was made of cartilage.
- B. Ectoparasitic; as they were found attached on fish skin with their circular sucking mouth.
- C. Paired fins and scales were absent, but 7 pairs of gill slits were present.

Which of the following species of animals did they consider to fit best with these characters ?

- (1) *Exocoetus* sp.
- (2) *Branchiostoma* sp.
- (3) *Petromyzon* sp.
- (4) *Scoliodon* sp.

143. Spermatogonia undergo a series of cell divisions to produce sperms. Select the correct statements from the following :

- A. Spermatogonia always undergo meiotic cell division.
- B. Primary spermatocytes divide mitotically to produce secondary spermatocytes.
- C. Secondary spermatocytes, through their second meiotic division, produce haploid spermatids.
- D. Spermatids produce spermatozoa through mitosis.
- E. Spermatids transform into spermatozoa by spermiogenesis.

Choose the **correct** answer from the options given below :

- (1) C and E only
- (2) A, C and E only
- (3) B, C and D only
- (4) A and E only

144. What is the probability of having children with 'O' blood group, where both mother and father are heterozygous for 'A' and 'B' blood group, respectively ?

- (1) 50%
- (2) 0%
- (3) 75%
- (4) 25%

145. Arrange the following events occurring in Renin-Angiotensin mechanism in the correct order :

- A. Increase in blood pressure and Glomerular filtration rate.
- B. Reabsorption of  $\text{Na}^+$  and water from distal parts of tubule due to Aldosterone.
- C. Fall in Glomerular filtration rate.
- D. Vasoconstriction by Angiotensin II and release of Aldosterone.
- E. Renin converts Angiotensinogen into Angiotensin I, followed by Angiotensin II.

Choose the **correct** answer from the options given below :

- (1) C, A, B, D, E
- (2) A, D, B, E, C
- (3) A, C, E, B, D
- (4) C, E, D, B, A

146. Match List I with List II :

| List I<br>(Respiratory<br>Volume)   | List II<br>(Capacity in mL) |
|-------------------------------------|-----------------------------|
| A. ERV (Expiratory Reserve Volume)  | I. 2500 – 3000 mL           |
| B. RV (Residual Volume)             | II. 500 mL                  |
| C. IRV (Inspiratory Reserve Volume) | III. 1000 – 1100 mL         |
| D. TV (Tidal Volume)                | IV. 1100 – 1200 mL          |

Choose the **correct** answer from the options given below :

- (1) A-III, B-I, C-IV, D-II
- (2) A-I, B-III, C-II, D-IV
- (3) A-III, B-IV, C-I, D-II
- (4) A-I, B-II, C-III, D-IV

147. Match List I with List II :

| List I           | List II                                   |
|------------------|---|
| A. Progestasert  | I. Barrier made of rubber used by females |
| B. Multiload 375 | II. Oral contraceptive                    |
| C. Diaphragm     | III. Hormone releasing IUD                |
| D. Saheli        | IV. Copper releasing IUD                  |

Choose the **correct** answer from the options given below :

- (1) A-III, B-IV, C-I, D-II  
(2) A-III, B-IV, C-II, D-I  
(3) A-IV, B-II, C-I, D-III  
(4) A-IV, B-III, C-I, D-II

148. Non-membrane bound cell organelles found in both prokaryotic and eukaryotic cells are \_\_\_\_\_.

- (1) Centrosomes  
(2) Ribosomes  
(3) Lysosomes  
(4) Mitochondria

149. Ecological pyramids represent the relationship between the organisms at different trophic levels and they are generally inverted for :

- (1) Pyramid of energy in pond ecosystem  
(2) Pyramid of biomass in sea  
(3) Pyramid of number in grassland  
(4) Pyramid of biomass in grassland

150. The flightless bird with forelimbs modified as paddle-like structures suited for swimming is known as :

- (1) *Struthio* (2) *Psittacula*  
(3) *Neophron* (4) *Aptenodytes*

151. Match List I with List II :

| List I<br>(Bioactive molecules) | List II<br>(Importance)                     |
|---------------------------------|---|
| A. Streptokinase                | I. Immunosuppressive agent                  |
| B. Statins                      | II. Removal of clots from the blood vessels |
| C. Lipases                      | III. Blood cholesterol-lowering agent       |
| D. Cyclosporin A                | IV. Detergent formulations                  |

Choose the **correct** answer from the options given below :

- (1) A-II, B-III, C-IV, D-I  
(2) A-IV, B-III, C-II, D-I  
(3) A-II, B-III, C-I, D-IV  
(4) A-III, B-II, C-I, D-I

152. Choose the correct statements regarding cell organelles and their inclusions.

- A. The endomembrane system includes Golgi complex, endoplasmic reticulum and mitochondria.  
B. Rough endoplasmic reticulum bears ribosomes on its surface.  
C. Both mitochondria and plastids have circular DNA.  
D. A network of microtubules, microfilaments and intermediate filaments present in the cytoplasm is called cytoskeleton.  
E. Mitochondrion is a single membrane-bound structure.

Choose the **correct** answer from the options given below :

- (1) C, D and E only  
(2) A and B only  
(3) A, B and C only  
(4) B, C and D only

153. Select the set of fishes which belong to the class Osteichthyes :

- (1) Devil fish, Cuttlefish and Hagfish
- (2) Starfish, Hagfish and Cuttlefish
- (3) Flying fish, Angel fish and Fighting fish
- (4) Saw fish, Fighting fish and Dog fish

154. In a population of a grasshopper species, the chromosome number of some members is 23 and some other members possess 24 chromosomes.

The 23 and 24 chromosome-bearing members in this species are \_\_\_\_\_.

- (1) all males
- (2) all females
- (3) females and males, respectively
- (4) males and females, respectively

155. The WBC count of a person's blood sample is 8000/cu.mm. How many eosinophils and lymphocytes would be in the same blood sample approximately ?

- (1) 160 – 240/cu.mm and 1600 – 2000/cu.mm, respectively
- (2) 100 – 120/cu.mm and 160 – 200/cu.mm, respectively
- (3) 300 – 500/cu.mm and 500 – 700/cu.mm, respectively
- (4) 300 – 500/cu.mm and 1200 – 1500/cu.mm, respectively

156. The toxin proteins isolated from *Bacillus thuringiensis*, coded by which of the following genes would control cotton bollworms and corn borer, respectively ?

- (1) *cryIAc* and *cryIIIAb*
- (2) *cryIAc* and *cryIIAb*
- (3) *cryIAc* and *cryIAb*
- (4) *cryIIAb* and *cryIAc*

157. Match List I with List II :

| List I<br>(Drug) |      | List II<br>(Effect)   |
|------------------|------|---|
| A. Nicotine      | I.   | Causes sense of euphoria and increased energy                             |
| B. Morphine      | II.  | Stimulates adrenal gland to release catecholamines into blood circulation |
| C. Heroin        | III. | Effective sedative and painkiller   |
| D. Cocaine       | IV.  | A depressant; slows down body function                                    |

Choose the correct answer from the options given below :

- (1) A-III, B-II, C-IV, D-I
- (2) A-II, B-III, C-IV, D-I
- (3) A-II, B-III, C-I, D-IV
- (4) A-III, B-II, C-I, D-IV

158. Match List I with List II related to muscular/skeletal system :

| List I                |      | List II   |
|-----------------------|------|---|
| A. Tetany             | I.   | Inflammation of joints  |
| B. Arthritis          | II.  | Autoimmune disorder affecting neuromuscular junction          |
| C. Myasthenia gravis  | III. | Wild contraction in muscle due to low $Ca^{++}$ in body fluid |
| D. Muscular dystrophy | IV.  | Progressive degeneration of skeletal muscle                   |

Choose the correct answer from the options given below :

- (1) A-III, B-I, C-II, D-IV
- (2) A-IV, B-III, C-II, D-I
- (3) A-I, B-II, C-III, D-IV
- (4) A-III, B-II, C-I, D-IV

159. In which animal do haploid cells divide mitotically to produce gametes ?

- (1) Male honeybees
- (2) Male grasshoppers
- (3) Male earthworms
- (4) Male frogs

160. In humans, respiration occurs in the following steps. Arrange these steps in the correct order.

- A. Diffusion of  $O_2$  and  $CO_2$  between blood and tissues
- B. Diffusion of  $O_2$  and  $CO_2$  across alveolar membrane
- C. Pulmonary ventilation by which atmospheric air is drawn in and  $CO_2$  rich alveolar air is released out
- D. Cellular respiration
- E. Transport of gases by the blood

Choose the **correct** answer from the options given below :

- (1) A, B, C, D, E
- (2) E, A, C, D, B
- (3) C, A, B, E, D
- (4) C, B, E, A, D

161. Arrange the following cell layers/structures around the female gamete, from outer to inner side :

- A. Zona pellucida
- B. Perivitelline space
- C. Corona radiata
- D. Plasma membrane of ovum

Choose the **correct** answer from the options given below :

- (1) C, A, D, B
- (2) C, A, B, D
- (3) D, B, A, C
- (4) A, C, B, D

162. The human protein named  $\alpha$ -1-antitrypsin, obtained from transgenic animals, is used for the treatment of \_\_\_\_\_.

- (1) Alzheimer's disease
- (2) Emphysema
- (3) Rheumatoid arthritis
- (4) Cystic fibrosis

163. Select the correct statements regarding cell membrane in eukaryotic cell.

- A. Membrane of human RBCs has approximately 52% protein.
- B. Major phospholipids are arranged in a bilayer.
- C. Extensions of the plasma membrane into the cell form mesosomes.
- D. Tails towards the inner part of lipids are hydrophobic and thus protected from aqueous medium.
- E. Glycocalyx is present on the outer surface of the plasma membrane.

Choose the **correct** answer from the options given below :

- (1) A, C and E only
- (2) B, C and E only
- (3) C, D and E only
- (4) A, B and D only

164. Male frogs can be distinguished from female frogs due to the presence of :

- A. Bulging eyes
- B. Vocal sacs
- C. Webbed digits in feet
- D. Copulatory pad on first digit of fore limbs
- E. Olive green-coloured skin with dark irregular spots

Choose the **correct** answer from the options given below :

- (1) B and D only
- (2) B and C only
- (3) A and B only
- (4) C and E only

165. Which of the following equations depicts Verhulst-Pearl logistic population growth ?

- (1)  $\frac{dN}{dt} = rN \left( \frac{K-N}{K} \right)$
- (2)  $\frac{dN}{dt} = rN \left( \frac{K+N}{K} \right)$
- (3)  $\frac{dN}{dt} = rN \left( \frac{K}{K-N} \right)$
- (4)  $\frac{dN}{dt} = rN \left( \frac{K-N}{N} \right)$

166. Choose the correct statements regarding frog's anatomy :

- A. Hepatic portal system is the special venous connection between liver and intestine.
- B. There are twelve pairs of cranial nerves arising from the brain.
- C. The ureters and oviducts open separately into the cloaca in female frogs.
- D. Hind-brain consists of cerebellum, medulla oblongata and optic lobes.
- E. Sinus venosus joins the right atrium of heart.

Choose the **correct** answer from the options given below :

- (1) B and D only
- (2) A, C and E only
- (3) A, B and C only
- (4) B and C only

167. Select the **incorrect** statements with reference to Rh grouping.

- A. Erythroblastosis foetalis is a condition observed having foetus with Rh<sup>-ve</sup> blood and mother with Rh<sup>+ve</sup> blood.
- B. Rh antigen is observed on RBCs in the majority of human beings.
- C. Before blood transfusion, Rh group should also be matched.
- D. Rh incompatibility is observed when a pregnant mother is Rh<sup>-ve</sup> and the foetus is Rh<sup>+ve</sup>.
- E. Erythroblastosis foetalis can be avoided by administering anti-Rh antibodies to the mother immediately after the delivery of the second child.

Choose the answer from the options given below :

- (1) A and E only
- (2) A and B only
- (3) B and C only
- (4) C and D only

168. Which of the following statements are correct with reference to human endoskeleton ?

- A. Human skull is monocondylic.
- B. The joint between any two adjoining vertebrae is a cartilaginous joint.
- C. In human beings, the number of cervical vertebrae is seven.
- D. All ribs except the last 2 pairs are bicephalic.
- E. The occipital bone of skull is articulated with atlas vertebra.

Choose the **correct** answer from the options given below :

- (1) A, B and D only
- (2) B and E only
- (3) B, C and E only
- (4) C, D and E only

169. Match List I with List II :

- | List I             | List II   |
|--------------------|---|
| A. Cortisol        | I. Stimulates the formation of alveoli in mammary glands                    |
| B. Aldosterone     | II. Produces anti-inflammatory reactions                                    |
| C. Cholecystokinin | III. Stimulates reabsorption of Na <sup>+</sup> and water from renal tubule |
| D. Progesterone    | IV. Stimulates secretion of pancreatic enzymes and bile juice               |

Choose the **correct** answer from the options given below :

- (1) A-III, B-II, C-IV, D-I
- (2) A-II, B-III, C-IV, D-I
- (3) A-IV, B-II, C-I, D-III
- (4) A-II, B-III, C-I, D-IV

170. The following are the stages of life cycle of *Plasmodium*. Arrange the stages in the proper order.

- A. The parasites reproduce asexually in RBCs, bursting the cells.
- B. The parasites reproduce asexually in liver cells, bursting the cells and releasing into blood.
- C. Gametocytes develop in RBCs.
- D. Sporozoites reach the liver through the blood.
- E. Female mosquito injects sporozoites into humans during bite.

Choose the **correct** answer from the options given below :

- ~~(1)~~ A, B, C, D, E      ~~(2)~~ E, D, B, A, C  
(3) C, A, B, D, E      (4) E, C, D, B, A

171. Select the **incorrect** statements from the following :

- A. Digestive system in Platyhelminthes is incomplete.
- B. Bilateral symmetry is a characteristic feature of adult Echinoderms.
- C. Pseudocoelom is possessed by Aschelminthes.
- D. Notochord is persistent throughout life in the class Chondrichthyes.
- E. Members of class Reptilia maintain a constant body temperature.

Choose the answer from the options given below :

- (1) B and E only  
(2) C and D only  
~~(3) A and C only~~  
(4) B and D only

172. The specific receptors for neurotransmitters in a synapse are present on \_\_\_\_\_.

- ~~(1)~~ Post-synaptic membrane
- (2) Pre-synaptic membrane
- (3) Myelin sheath
- (4) Schwann cell

173. Choose the correct statements regarding muscle contraction.

- A. A motor neuron carries a signal sent by the Central Nervous System (CNS) to the sarcolemma of the muscle fibre.
- B. The neural signal generates an action potential which causes the release of  $Ca^{++}$  into sarcoplasm.
- C. Increase in  $Ca^{++}$  inactivates the actin for breaking cross bridges.
- D. Actin binds to the myosin head to form a cross bridge.
- E. Shortening of sarcomere takes place, by pulling actin filaments towards the centre of 'A' band.

Choose the **correct** answer from the options given below :

- (1) A, B, D and E only      (2) C and D only  
(3) C and E only      (4) A and B only

174. Which of the following is **not** an example of convergent evolution ?

- (1) Eyes of octopuses and mammals
- ~~(2)~~ Fore limbs of whales and bats
- (3) Wings of butterflies and birds
- (4) Flippers of penguins and dolphins

175. The JGA (Juxta Glomerular Apparatus) is a special sensitive region formed by cellular modifications in \_\_\_\_\_ related to the same nephron.

- ~~(1)~~ Distal convoluted tubule and efferent renal arteriole
- (2) Proximal convoluted tubule and afferent renal arteriole
- (3) Distal convoluted tubule and afferent renal arteriole
- (4) Proximal convoluted tubule and efferent renal arteriole

176. The following reaction depicts the activity of a particular class of enzymes :

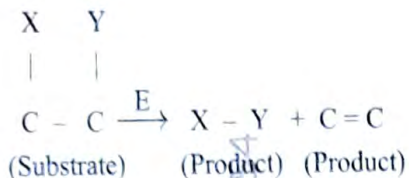

Identify the enzyme class 'E' from the following options :

- (1) Ligases
- (2) Lyases
- (3) Isomerases
- (4) Transferases

177. Match List I with List II :

| List I              | List II                                 |
|---------------------|---|
| A. Molluscs         | I. Pulmonary respiration only           |
| B. Reptiles         | II. Branchial respiration               |
| C. Adult amphibians | III. Cellular respiration               |
| D. Amoeba           | IV. Pulmonary and Cutaneous respiration |

Choose the **correct** answer from the options given below :

- (1) A-III, B-II, C-I, D-IV
- (2) A-II, B-I, C-IV, D-III
- (3) A-II, B-I, C-III, D-IV
- (4) A-I, B-II, C-IV, D-III

178. What is the reason behind production of large holes in 'Swiss Cheese' ?

- (1) The production of large amount of  $\text{CO}_2$  by *Clostridium butydicum*
- (2) The production of large amount of  $\text{CO}_2$  and  $\text{H}_2$  by *Trichoderma polysporum*
- (3) The production of large amount of  $\text{CO}_2$  and  $\text{H}_2$  by lactic acid bacteria called *Lactobacillus*
- (4) The production of large amount of  $\text{CO}_2$  by *Propionibacterium sharmanii*

179. Match List I with List II with respect to chronology of evolution of life forms :

| List I           | List II   |
|------------------|---|
| A. About 65 mya  | I. Jawless fish probably evolved                      |
| B. About 500 mya | II. The dinosaurs suddenly disappeared from the earth |
| C. About 350 mya | III. Seaweeds and few plants probably existed         |
| D. About 320 mya | IV. Invertebrates were formed and became active       |

Choose the **correct** answer from the options given below :

- (1) A-II, B-IV, C-I, D-III
- (2) A-II, B-IV, C-III, D-I
- (3) A-I, B-II, C-III, D-IV
- (4) A-III, B-IV, C-I, D-II

180. Choose the correct statements regarding population interactions between two species.

- A. In both parasitism and commensalism, only one species benefits and the other species is harmed.
- B. Both species benefit in mutualism.
- C. Both species benefit in commensalism.
- D. In parasitism, only one species benefits and the other species is harmed.
- E. In amensalism, one species is harmed and the other is unaffected.

Choose the **correct** answer from the options given below :

- (1) A and D only
- (2) A and B only
- (3) B and E only
- (4) B, D and E only

SPACE FOR ROUGH WORK



110553454

